

Name _____

Area of Composite Figures Worksheet #1

Find the area of the shaded region.

1.

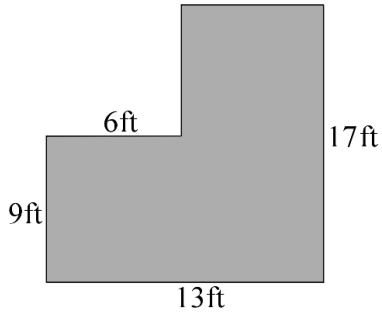

2.

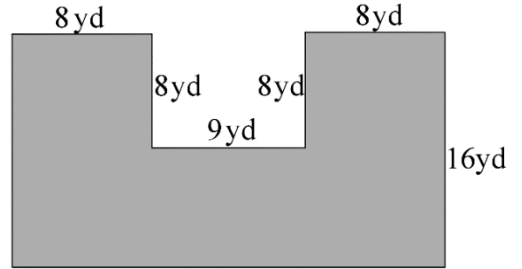

3.

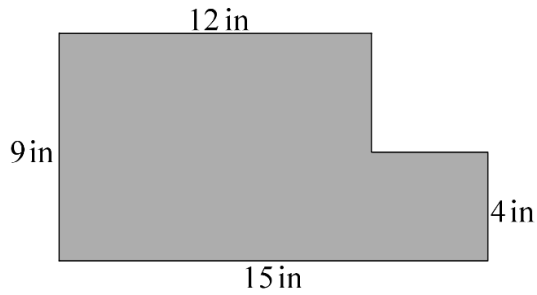

4.

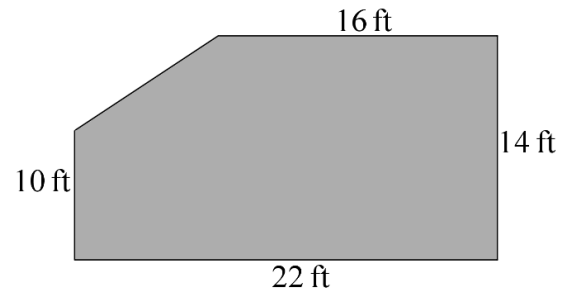

5.

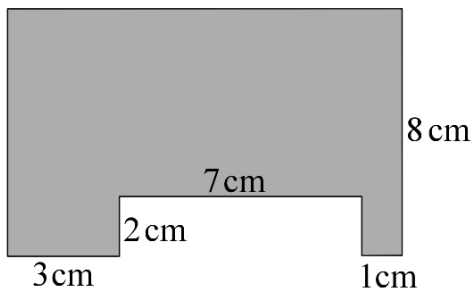

6.

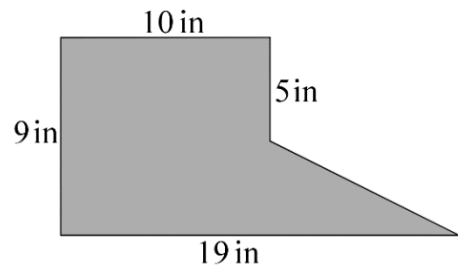

7.

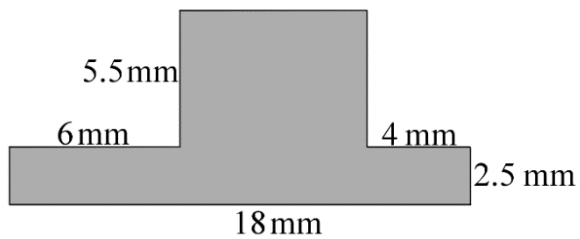

8.

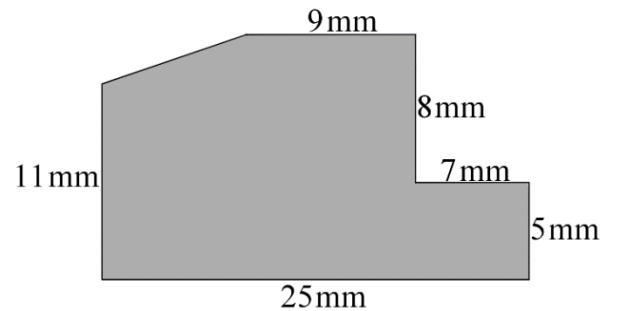

Area of Composite Figures Worksheet #1 Answers

Find the area of the shaded region.

1. 173 ft^2

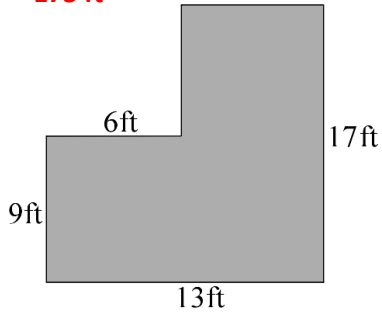

2. 328 yd^2

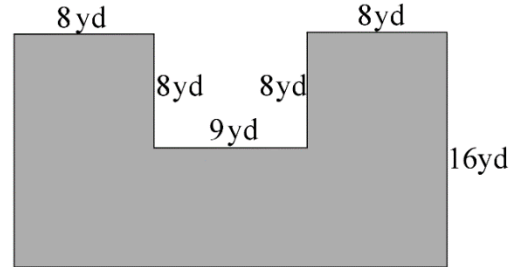

3. 120 in^2

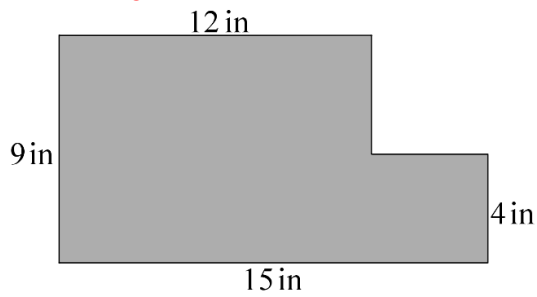

4. 296 ft^2

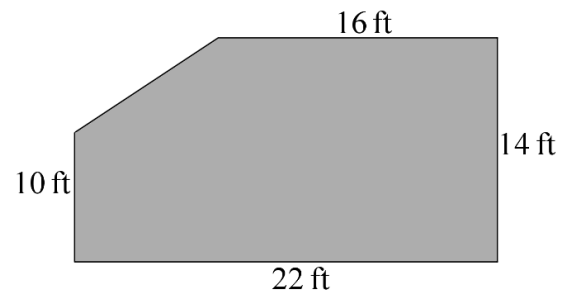

5. 74 cm^2

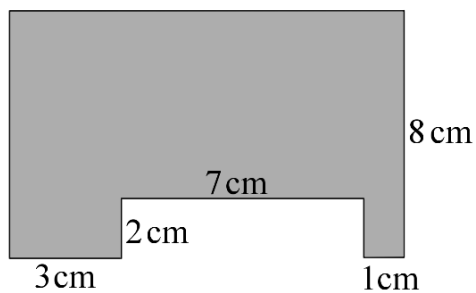

6. 108 in^2

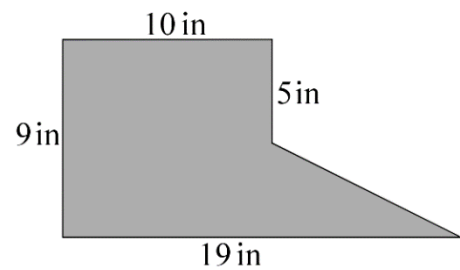

7. 89 mm^2

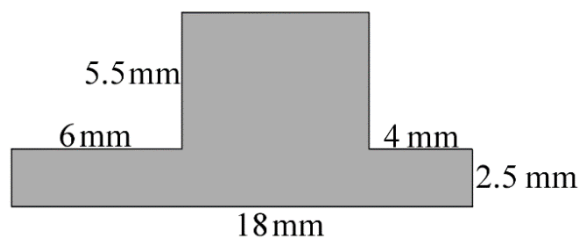

8. 260 mm^2

